

RoHS   
Compliant

BOMcheck.net

Color: ■

**Derating-Kurve**  
1-Leiter-Federleiste (231-102/026-000) mit  
1-Leiter-Stiftleiste (231-602)  
Rastermaß 5 mm / Leiterquerschnitt 2,5 mm<sup>2</sup> „f“  
In Anlehnung an: EN 60512-5-2 / Reduktionsfaktor 0,8

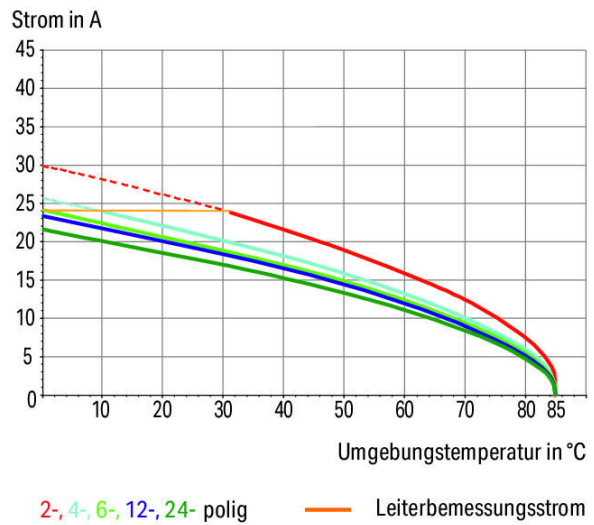

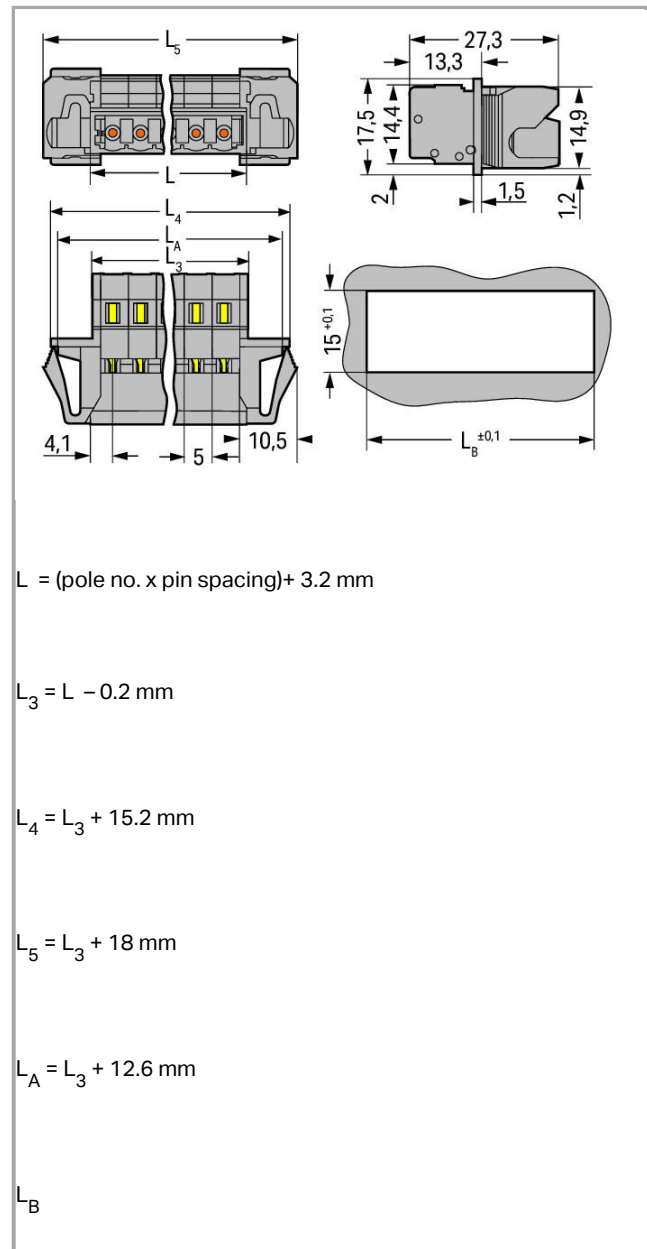
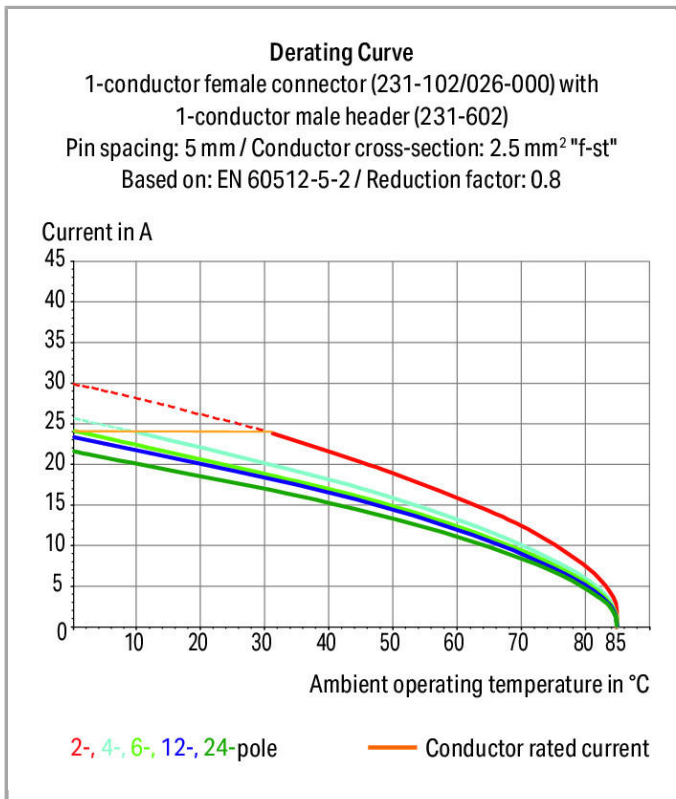

### Item description

- Universal connection for all conductor types
- Easy cable pre-assembly and on-unit wiring via vertical and horizontal CAGE CLAMP® actuation
- For wire-to-wire and board-to-wire connections
- Versions available with snap-in mounting feet or flanges for panel or through-panel mounting
- With coding fingers

### Safety information 1:



The *MULTI CONNECTION SYSTEM (MCS)* is designed without breaking capacity for compliance with DIN EN 61984. When used as intended, MCS Connectors shall not be connected/disconnected when live or under load. The circuit design should ensure header pins, which can be touched, are not live when unmated.

## Data

### Electrical data

#### Ratings per IEC/EN 60664-1

Rated voltage (III / 3)	320 V
Rated impulse voltage (III / 3)	4 kV
Rated voltage (III / 2)	320 V
Rated impulse voltage (III / 2)	4 kV
Rated voltage (II / 2)	630 V
Rated impulse voltage (II / 2)	4 kV
Rated current	12 A

#### Approvals per UL 1059

Rated voltage UL (Use Group B)	300 V
Rated current UL (Use Group B)	15 A
Rated voltage UL (Use Group D)	300 V
Rated current UL (Use Group D)	10 A

#### Approvals per UL 1977

Rated voltage per UL 1977 (factory wiring only)	600 V
Rated current per UL 1977 (factory wiring only)	15 A

#### Approvals per CSA

Rated voltage CSA (Use Group B)	300 V
Rated current CSA (Use Group B)	15 A
Rated voltage CSA (Use Group D)	300 V
Rated current CSA (Use Group D)	10 A

### Connection data

Connection technology	CAGE CLAMP®
Actuation type	Operating tool
Solid conductor	0.08 ... 2.5 mm <sup>2</sup> / 28 ... 12 AWG
Fine-stranded conductor	0.08 ... 2.5 mm <sup>2</sup> / 28 ... 12 AWG
Fine-stranded conductor with ferrule with plastic collar	0.25 ... 1.5 mm <sup>2</sup>
Fine-stranded conductor with ferrule without plastic collar	0.25 ... 2.5 mm <sup>2</sup>
Strip length	8 ... 9 mm / 0.31 ... 0.35 inch



No. of poles	3
Total number of connection points	3
Total number of potentials	3
Number of connection types	1
Number of levels	1
Conductor entry direction to mating direction	0°

### Geometrical Data

Pin spacing	5 mm / 0.197 inch
Width	36 mm / 1.417 inch
Height	17.5 mm / 0.689 inch
Depth	27.5 mm / 1.083 inch

### Mechanical data

Gehäuseblechstärke	0.5 ... 2.5 mm / 0.02 ... 0.098 inch
Mounting type	Snap-in
Type of mounting	Feed-through mounting

### Plug connection

Contact type (pluggable connector)	Male connector/plug
Connector connection type	for conductors
Mismating protection	No

### Material Data

Color	gray
Material group	I
Insulating material	Polyamide 66 (PA 66)
Flammability class per UL94	V0
Clamping spring material	Chrome nickel spring steel (CrNi)
Contact material	Electrolytic copper (E <sub>Cu</sub> )
Contact plating	tin-plated
Fire load	0.152 MJ
Weight	6.93 g

### Environmental Requirements

Limit temperature range	-60 ... +100 °C
-------------------------	-----------------



### Commercial data

Product Group	3 (Multi Conn. System)
---------------	------------------------



Country of origin	DE
GTIN	4050821216018
Customs Tariff No.	85366990990

## Approvals / Certificates



### Country specific Approvals

Logo	Approval	Additional Approval Text	Certificate name
	<b>CB</b> DEKRA Certification B.V.	IEC 61984	NL-39756
	<b>CSA</b> DEKRA Certification B.V.	C22.2	1466354
	<b>CSA</b> DEKRA Certification B.V.	C22.2	1466354

### Ship Approvals















Logo	Approval	Additional Approval Text	Certificate name
	<b>ABS</b> American Bureau of Shipping	-	14- HG1241537- PDA
	<b>DNV GL</b> Det Norske Veritas, Germanischer Lloyd	-	TAE000016Z



















### UL-Approvals

















Logo	Approval	Additional Approval Text	Certificate name
	<b>UR</b> UL International Germany GmbH	UL 1977	E45171
	<b>UR</b> UL International Germany GmbH	UL 1977	E45171

















### Compatible products

## General accessories

	<b>Item no.: 231-668</b> Lockout caps; for covering unused clamping units	231-668
<b>Jumper</b>		
	<b>Item no.: 231-902</b> Comb-style jumper bar; for 5 mm and 5.08 mm pin spacing; reduces conductor size to 1.5 mm	231-902
	<b>Item no.: 231-903</b> Comb-style jumper bar; 3-way; suitable for 231 Series female connectors; with 5 mm pin spacing; insulated	231-903
	<b>Item no.: 231-905</b> Comb-style jumper bar; 5-way; suitable for 231 Series female connectors; with 5 mm pin spacing; insulated	231-905
	<b>Item no.: 231-907</b> Comb-style jumper bar; 7-way; suitable for 231 Series female connectors; with 5 mm pin spacing; insulated	231-907
	<b>Item no.: 231-910</b> Comb-style jumper bar; 10-way; suitable for 231 Series female connectors; with 5 mm pin spacing; insulated	231-910
<b>Strain relief plate</b>		
	<b>Item no.: 232-603</b> Strain relief housing	232-603
<b>ferrule</b>		
	<b>Item no.: 216-101</b> Ferrule; Sleeve for 0.5 mm <sup>2</sup> / AWG 22; uninsulated; electro-tin plated	216-101
	<b>Item no.: 216-102</b> Ferrule; Sleeve for 0.75 mm <sup>2</sup> / AWG 20; uninsulated; electro-tin plated	216-102
	<b>Item no.: 216-103</b> Ferrule; Sleeve for 1 mm <sup>2</sup> / AWG 18; uninsulated; electro-tin plated	216-103
	<b>Item no.: 216-104</b> Ferrule; Sleeve for 1.5 mm <sup>2</sup> / AWG 16; uninsulated; electro-tin plated	216-104
	<b>Item no.: 216-106</b> Ferrule; Sleeve for 2.5 mm <sup>2</sup> / AWG 14; uninsulated; electro-tin plated	216-106
	<b>Item no.: 216-121</b> Ferrule; Sleeve for 0.5 mm <sup>2</sup> / AWG 22; uninsulated; electro-tin plated	216-121
	<b>Item no.: 216-122</b> Ferrule; Sleeve for 0.75 mm <sup>2</sup> / AWG 20; uninsulated; electro-tin plated	216-122
	<b>Item no.: 216-123</b> Ferrule; Sleeve for 1 mm <sup>2</sup> / AWG 18; uninsulated; electro-tin plated	216-123

	<b>Item no.: 216-124</b> Ferrule; Sleeve for 1.5 mm <sup>2</sup> / AWG 16; uninsulated; electro-tin plated	216-124
	<b>Item no.: 216-131</b> Ferrule; Sleeve for 0.25 mm <sup>2</sup> / AWG 24; uninsulated; electro-tin plated	216-131
	<b>Item no.: 216-132</b> Ferrule; Sleeve for 0.34 mm <sup>2</sup> / AWG 24; uninsulated; electro-tin plated	216-132
	<b>Item no.: 216-141</b> Ferrule; Sleeve for 0.5 mm <sup>2</sup> / 20 AWG; uninsulated; electro-tin plated; electrolytic copper; gastight crimped; acc. to DIN 46228, Part 1/08.92	216-141
	<b>Item no.: 216-142</b> Ferrule; Sleeve for 0.75 mm <sup>2</sup> / 18 AWG; uninsulated; electro-tin plated; electrolytic copper; gastight crimped; acc. to DIN 46228, Part 1/08.92	216-142
	<b>Item no.: 216-143</b> Ferrule; Sleeve for 1 mm <sup>2</sup> / AWG 18; uninsulated; electro-tin plated; electrolytic copper; gastight crimped; acc. to DIN 46228, Part 1/08.92	216-143
	<b>Item no.: 216-144</b> Ferrule; Sleeve for 1.5 mm <sup>2</sup> / AWG 16; uninsulated; electro-tin plated; electrolytic copper; gastight crimped; acc. to DIN 46228, Part 1/08.92	216-144
	<b>Item no.: 216-151</b> Ferrule; Sleeve for 0.25 mm <sup>2</sup> / AWG 24; uninsulated; electro-tin plated	216-151
	<b>Item no.: 216-152</b> Ferrule; Sleeve for 0.34 mm <sup>2</sup> / AWG 24; uninsulated; electro-tin plated	216-152
	<b>Item no.: 216-201</b> Ferrule; Sleeve for 0.5 mm <sup>2</sup> / 20 AWG; insulated; electro-tin plated	216-201
	<b>Item no.: 216-202</b> Ferrule; Sleeve for 0.75 mm <sup>2</sup> / 18 AWG; insulated; electro-tin plated	216-202
	<b>Item no.: 216-203</b> Ferrule; Sleeve for 1 mm <sup>2</sup> / AWG 18; insulated; electro-tin plated	216-203
	<b>Item no.: 216-204</b> Ferrule; Sleeve for 1.5 mm <sup>2</sup> / AWG 16; insulated; electro-tin plated	216-204
	<b>Item no.: 216-221</b> Ferrule; Sleeve for 0.5 mm <sup>2</sup> / 20 AWG; insulated; electro-tin plated	216-221
	<b>Item no.: 216-222</b> Ferrule; Sleeve for 0.75 mm <sup>2</sup> / 18 AWG; insulated; electro-tin plated	216-222
	<b>Item no.: 216-223</b> Ferrule; Sleeve for 1 mm <sup>2</sup> / AWG 18; insulated; electro-tin plated	216-223
	<b>Item no.: 216-224</b> Ferrule; Sleeve for 1.5 mm <sup>2</sup> / AWG 16; insulated; electro-tin plated	216-224
	<b>Item no.: 216-241</b> Ferrule; Sleeve for 0.5 mm <sup>2</sup> / 20 AWG; insulated; electro-tin plated; electrolytic copper; gastight crimped; acc. to DIN 46228, Part 4/09.90	216-241
	<b>Item no.: 216-242</b> Ferrule; Sleeve for 0.75 mm <sup>2</sup> / 18 AWG; insulated; electro-tin plated; electrolytic copper; gastight crimped; acc. to DIN 46228, Part 4/09.90	216-242

	<b>Item no.: 216-243</b> Ferrule; Sleeve for 1 mm <sup>2</sup> / AWG 18; insulated; electro-tin plated; electrolytic copper; gastight crimped; acc. to DIN 46228, Part 4/09.90	216-243
	<b>Item no.: 216-244</b> Ferrule; Sleeve for 1.5 mm <sup>2</sup> / AWG 16; insulated; electro-tin plated; electrolytic copper; gastight crimped; acc. to DIN 46228, Part 4/09.90	216-244
	<b>Item no.: 216-262</b> Ferrule; Sleeve for 0.75 mm <sup>2</sup> / 18 AWG; insulated; electro-tin plated; electrolytic copper; gastight crimped; acc. to DIN 46228, Part 4/09.90	216-262
	<b>Item no.: 216-263</b> Ferrule; Sleeve for 1 mm <sup>2</sup> / AWG 18; insulated; electro-tin plated; electrolytic copper; gastight crimped; acc. to DIN 46228, Part 4/09.90	216-263
	<b>Item no.: 216-264</b> Ferrule; Sleeve for 1.5 mm <sup>2</sup> / AWG 16; insulated; electro-tin plated; electrolytic copper; gastight crimped; acc. to DIN 46228, Part 4/09.90	216-264
	<b>Item no.: 216-284</b> Ferrule; Sleeve for 1.5 mm <sup>2</sup> / AWG 16; insulated; electro-tin plated; electrolytic copper; gastight crimped; acc. to DIN 46228, Part 4/09.90	216-284
	<b>Item no.: 216-301</b> Ferrule; Sleeve for 0.25 mm <sup>2</sup> / AWG 24; insulated; electro-tin plated	216-301
	<b>Item no.: 216-302</b> Ferrule; Sleeve for 0.34 mm <sup>2</sup> / 22 AWG; insulated; electro-tin plated	216-302
	<b>Item no.: 216-321</b> Ferrule; Sleeve for 0.25 mm <sup>2</sup> / AWG 24; insulated; electro-tin plated	216-321
	<b>Item no.: 216-322</b> Ferrule; Sleeve for 0.34 mm <sup>2</sup> / 22 AWG; insulated; electro-tin plated	216-322
<b>tools</b>		
	<b>Item no.: 209-130</b> Operating tool; suitable for 264, 280 and 281 Series; 1-way; of insulating material	209-130
	<b>Item no.: 209-132</b> Operating tool; for connecting comb-style jumper bar; 2-way; of insulating material	209-132
	<b>Item no.: 210-250</b> Operating tool; for female and male connectors with CAGE CLAMP® connection; MCS MIDI & MINI	210-250
	<b>Item no.: 210-657</b> Operating tool with partially insulated shaft; Blade (3.5 x 0.5) mm; short	210-657
	<b>Item no.: 210-720</b> Operating tool with partially insulated shaft; Type 2, blade (3.5 x 0.5) mm	210-720
	<b>Item no.: 231-131</b> Push-button; for female and male connectors; loose	231-131
	<b>Item no.: 231-159</b> Operating tool; for male and female connectors with CAGE CLAMP®; of Series 231, 232, 721, 722, 723, 731, 732	231-159
	<b>Item no.: 231-231</b> Combination operating tool; for male and female connectors with CAGE CLAMP®	231-231
	<b>Item no.: 231-291</b>	

	Operating tool; for male and female connectors with CAGE CLAMP®; loose	231-291
	<b>Item no.: 280-432</b> Operating tool; of insulating material; 2-way	280-432
	<b>Item no.: 280-433</b> Operating tool; of insulating material; 3-way	280-433
	<b>Item no.: 280-434</b> Operating tool; of insulating material; 4-way	280-434
	<b>Item no.: 280-435</b> Operating tool; of insulating material; 5-way	280-435
	<b>Item no.: 280-436</b> Operating tool; of insulating material; 6-way	280-436
	<b>Item no.: 280-437</b> Operating tool; of insulating material; 7-way	280-437
	<b>Item no.: 280-438</b> Operating tool; of insulating material; 8-way	280-438
	<b>Item no.: 280-440</b> Operating tool; of insulating material; 10-way	280-440
<b>Marking accessories</b>		
	<b>Item no.: 210-833</b> Marking strips; on reel; 6 mm wide; plain; Self-adhesive	210-833
	<b>Item no.: 210-834</b> Marking strips; on reel; 5 mm wide; plain; Self-adhesive	210-834
<b>Coding</b>		
	<b>Item no.: 231-129</b> Coding key; snap-on type	231-129
	<b>Item no.: 231-130</b> Coding key; snap-on type	231-130
<b>Insulation stop</b>		
	<b>Item no.: 231-670</b> Insulation stop; 0.08-0.2 mm <sup>2</sup> / 0.2 mm <sup>2</sup> "s"	231-670
	<b>Item no.: 231-671</b> Insulation stop; 0.25 - 0.5 mm <sup>2</sup>	231-671
	<b>Item no.: 231-672</b> Insulation stop; 0.75 - 1 mm <sup>2</sup>	231-672

**Downloads****CAD/CAE - Smart Data****CAD data**

3D Download 231-603/114-000	URL	Download



Subject to changes.

---